



LE INTERGRAPH SMART™ SOLUTIONS E I PROCESSI DOWNSTREAM: E.G.: SISTEMA INTEGRATO PER LA GESTIONE MULTIRISCHIO

INFORMATION MANAGEMENT & PROJECT GOVERNANCE

FONDAZIONE MEDIATERRANEO

Via Portobello, 14 - Sestri Levante (GE), Apr. 10th 11th 2014

Maurizio M. GRANATA & Angelo ZAIA



LE INTERGRAPH SMART™ SOLUTIONS E PROCESSI DOWNSTREAM E.G.: SISTEMA INTEGRATO PER LA GESTIONE MULTIRISCHIO



What's
Smart™



Multi-risks
Management

Q&A

The World
around INGR
Smart™



Progetto
SIGMA

LE INTERGRAPH SMART™ SOLUTIONS E PROCESSI DOWNSTREAM E.G.: SISTEMA INTEGRATO PER LA GESTIONE MULTIRISCHIO

What's
Smart™

The World
around INGR
Smart™

Multi-risks
Management

Progetto
SIGMA

Q&A

Information Value

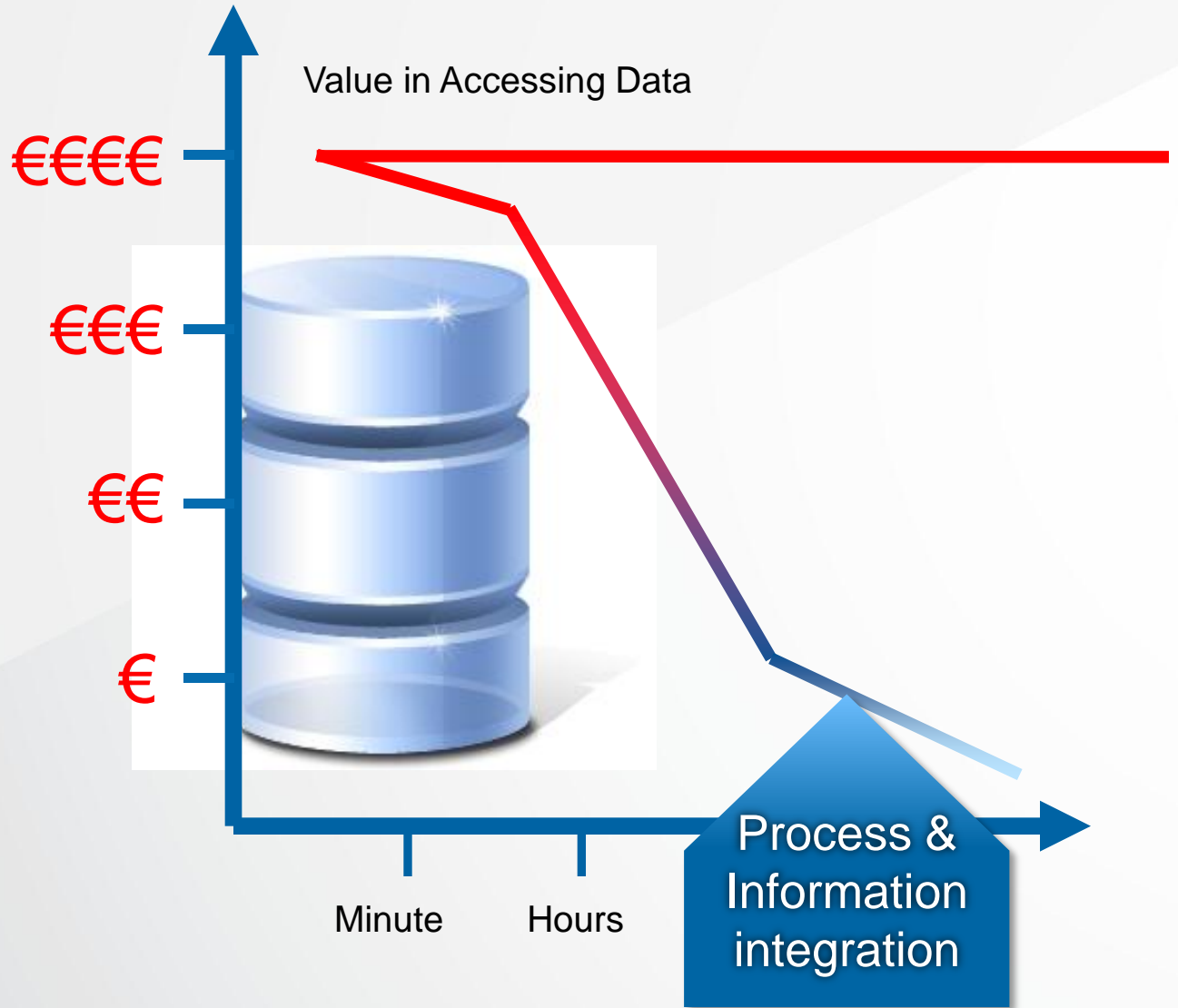

Intergraph Smart™ Technology

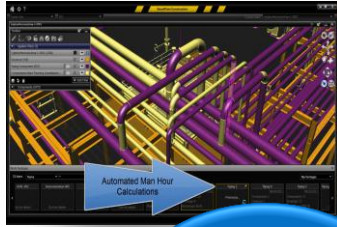

Work Sharing

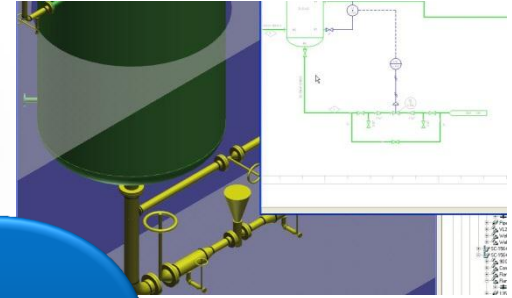

Object Correlation

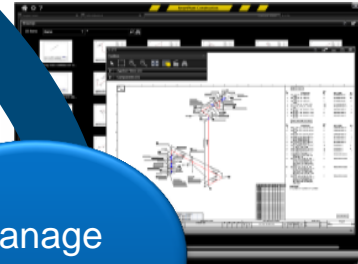

Manage Changes

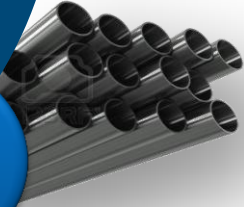

Materials & Execution

Specify Check Assess

| Mechanical Completion Checklist | | | | EOSA Electrical - Control & Relay Panel | | INTERGRAPH |
|---|--|-------------|------|---|---------|------------|
| Check No. | Tag Description | Contr. Area | Unit | CWP | Page: 1 | |
| P14F00E001A | System, Notifications, Safety Description | | | | | |
| OK | PR | N/A | | | | |
| Description of Check / Action to be made: | | | | | | |
| 1 | Non-plate labels correct in accordance with the data sheet | | | | | |
| 2 | Clean and free from external damage | | | | | |
| 3 | Equipment, fittings and mountings correct | | | | | |
| 4 | Parting to project specification and arrangement complete | | | | | |
| 5 | Equipment carries correct circuit identification | | | | | |
| 6 | Loose wires correctly plugged | | | | | |
| 7 | Labels and seals fitted correctly and undamaged | | | | | |
| 8 | Mechanical covers all fully correct, none missing | | | | | |
| 9 | Internal clean, dry, free from damage, packing and preservations removed | | | | | |



Capture Real Assets

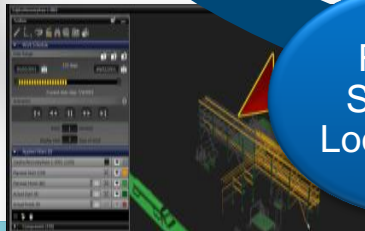

Review Simulate Look Ahead

Retrieve & Operate



Automation



Intergraph Smart™ Technology

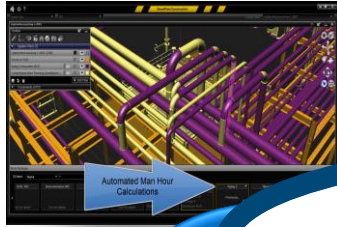

Progetto SIGMA

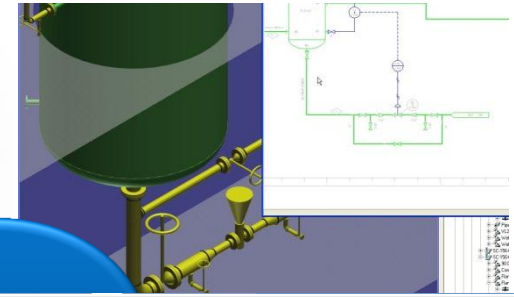

Automated

Corr



ive &
ate

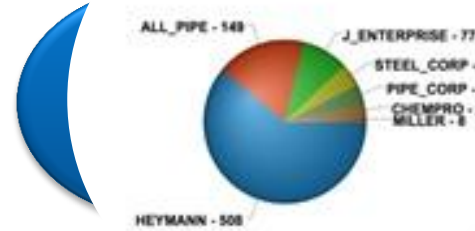
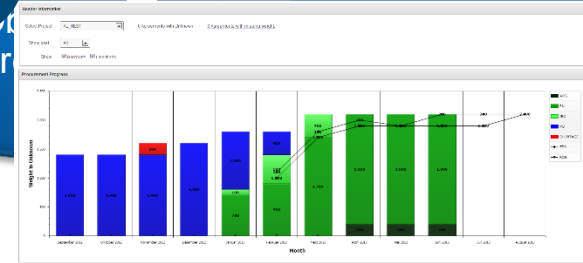

Capture
al Assets



review
mulator
Ahe



Spe
Che
Ass

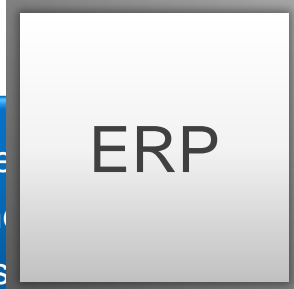

Material
Secu

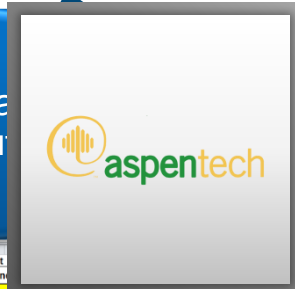

| Item | Unit | CWP | Status |
|---|------|-----|--------|
| Alignment, fittings and mountings correct | | | |
| Earthing to project specification and arrangement complete | | | |
| Equipment carries correct circuit identification | | | |
| Isolator entries correctly plugged | | | |
| Isolators and locks fitted correctly and undamaged | | | |
| Hardware covers all bolts correct, none missing | | | |
| Internal clean, dry, free from damage, packing and obstructions removed | | | |

LE INTERGRAPH SMART™ SOLUTIONS E PROCESSI DOWNSTREAM E.G.: SISTEMA INTEGRATO PER LA GESTIONE MULTIRISCHIO

What's
Smart™

The World
around INGR
Smart™

Multi-risks
Management

Progetto
SIGMA

Q&A



Scenario

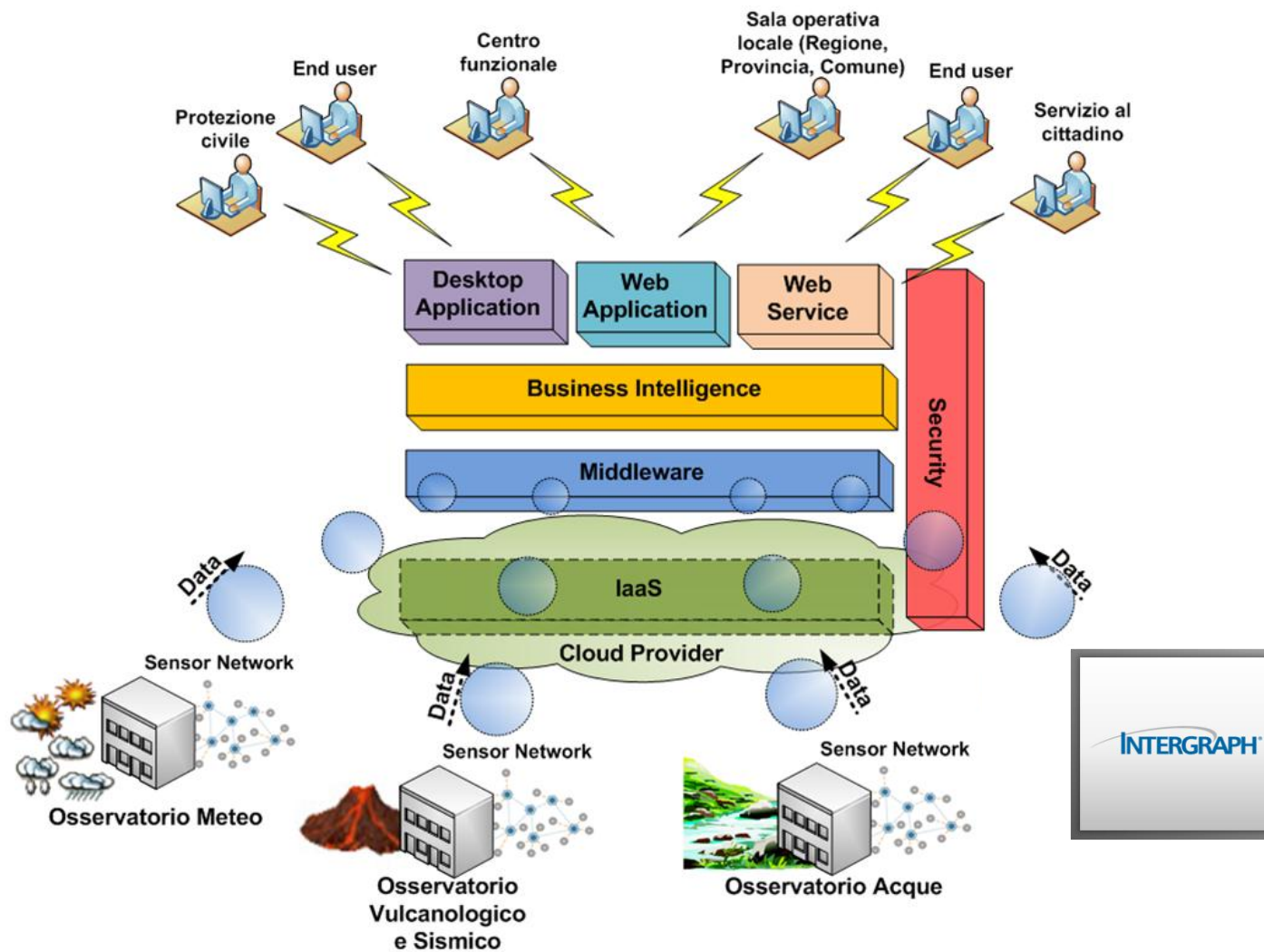

Partecipanti

- STMicroelectronics
- Insirio
- Istituto Nazionale di Geofisica e Vulcanologia
- Censis
- CNR
- Numerose Università Italiane
- Numerosi Centri di Ricerca

Attori coinvolti



Copertura Sensor Network

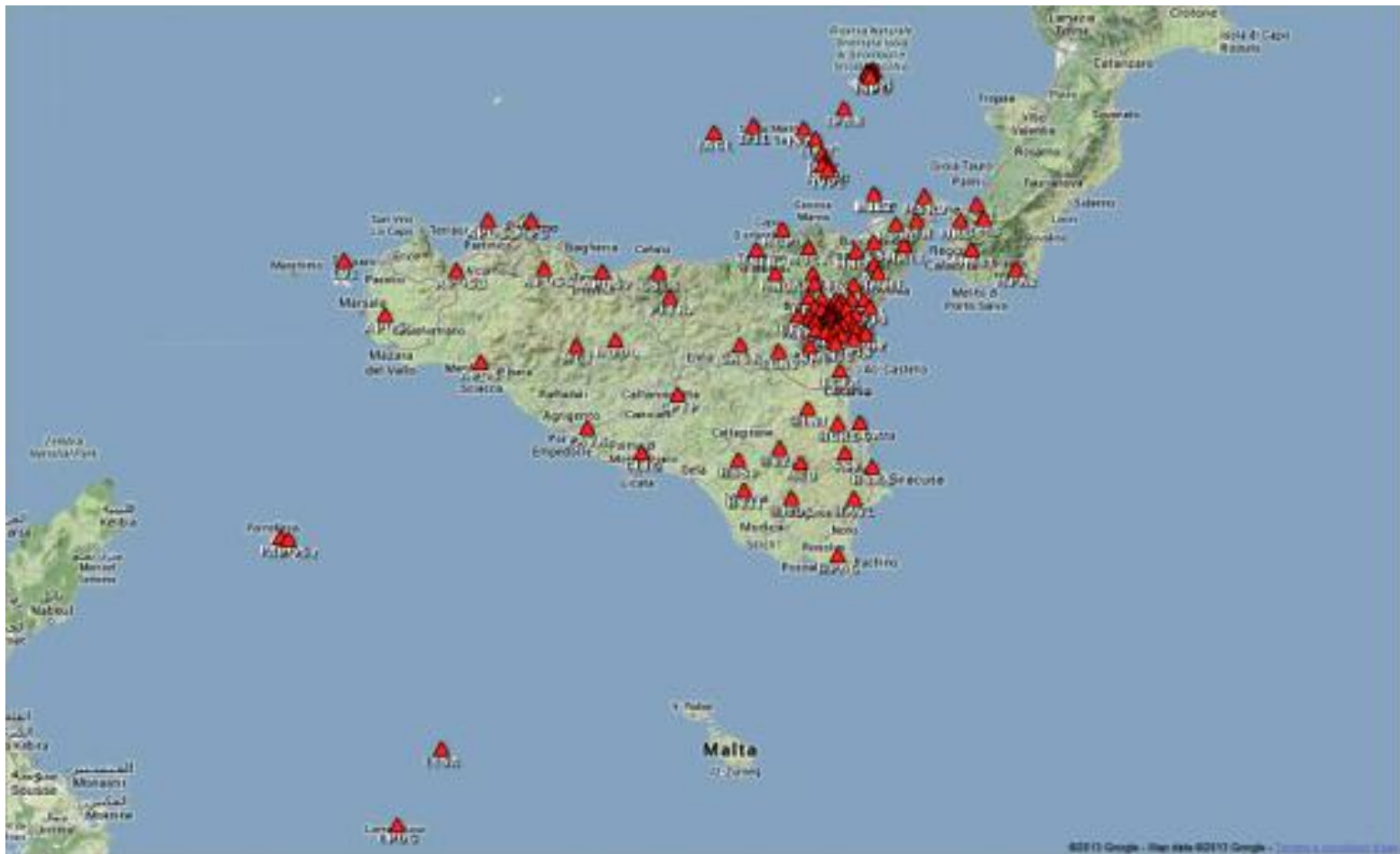

Impatto evento sismico su area industriale

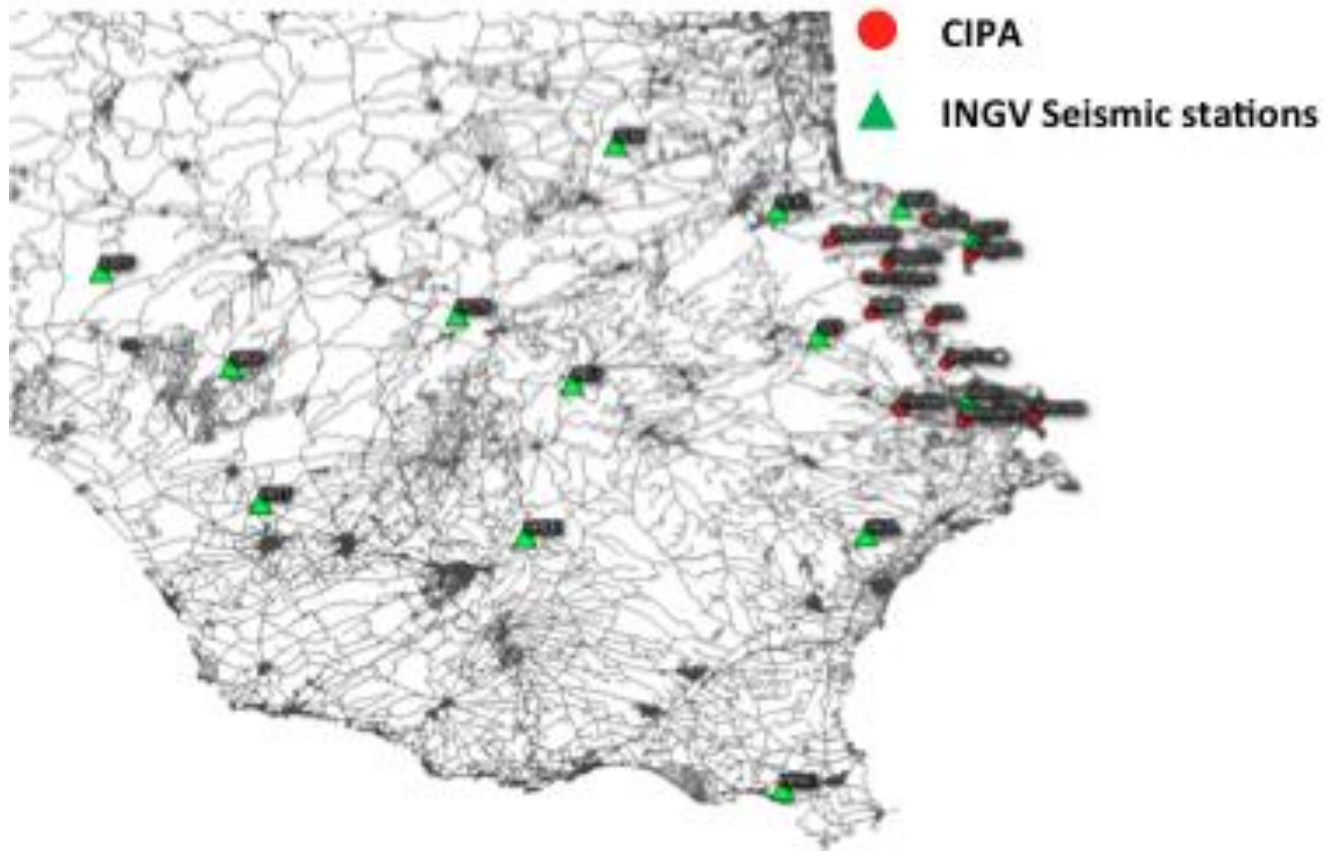

Impatto evento sismico su area industriale

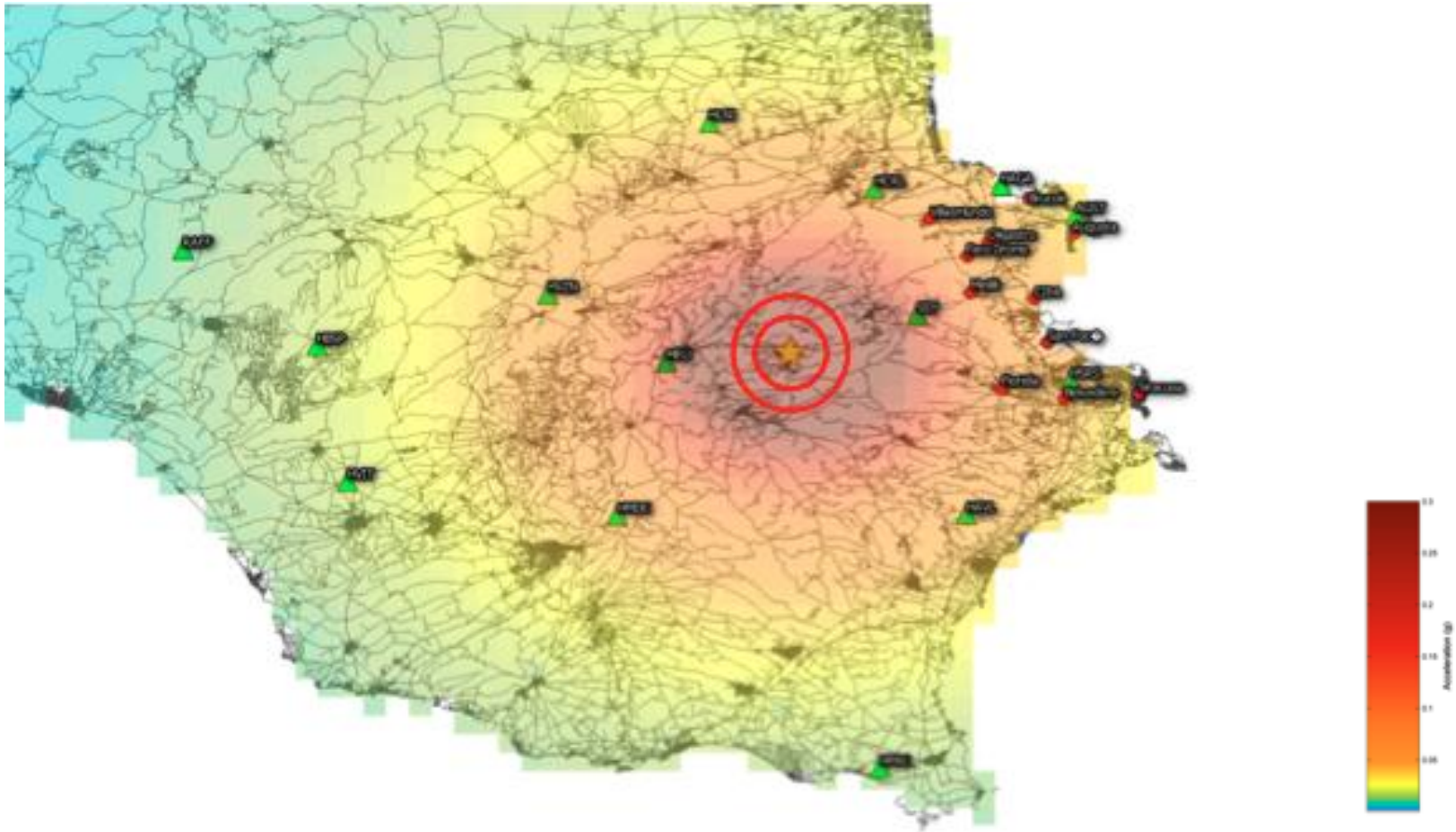

Multirischio

Evento sismico – Attività vulcanica

Attività vulcanica

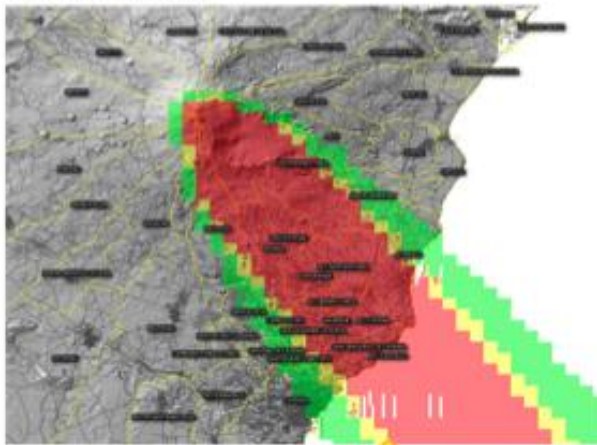

Evento sismico

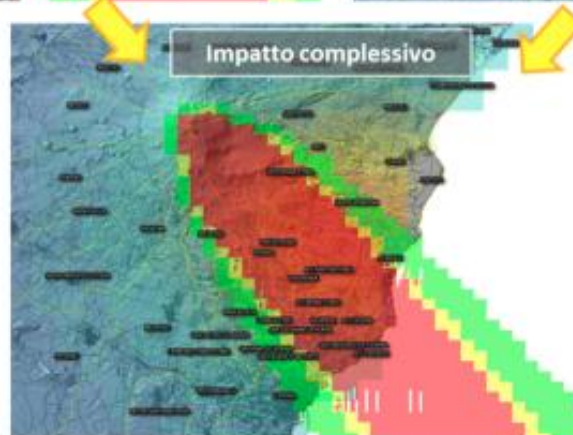
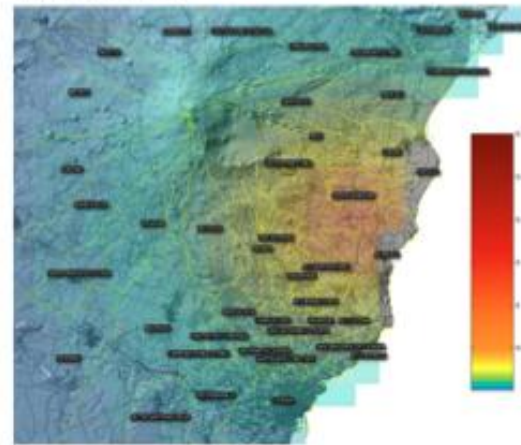

Multirischio

Attività vulcanica

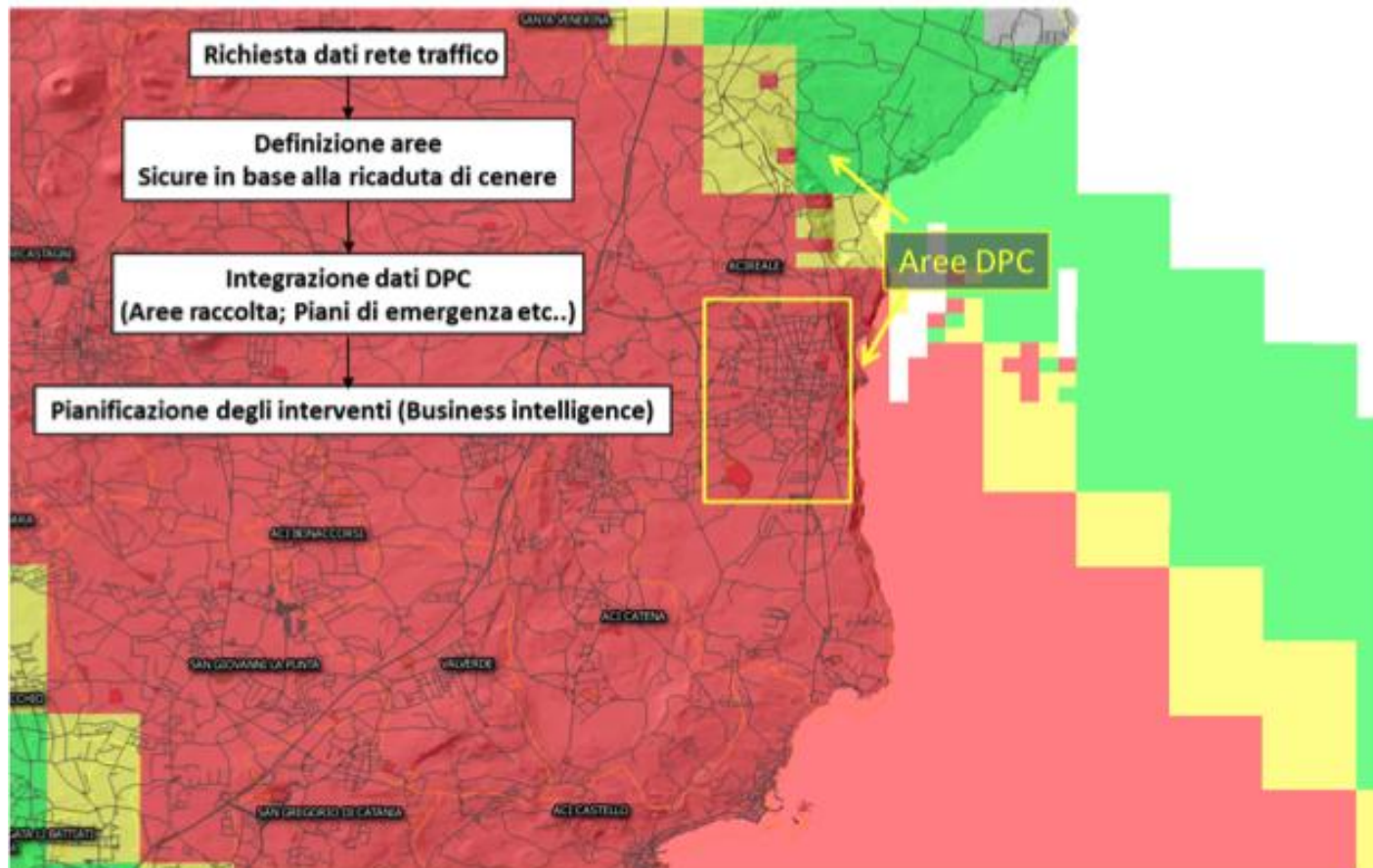

Multirischio

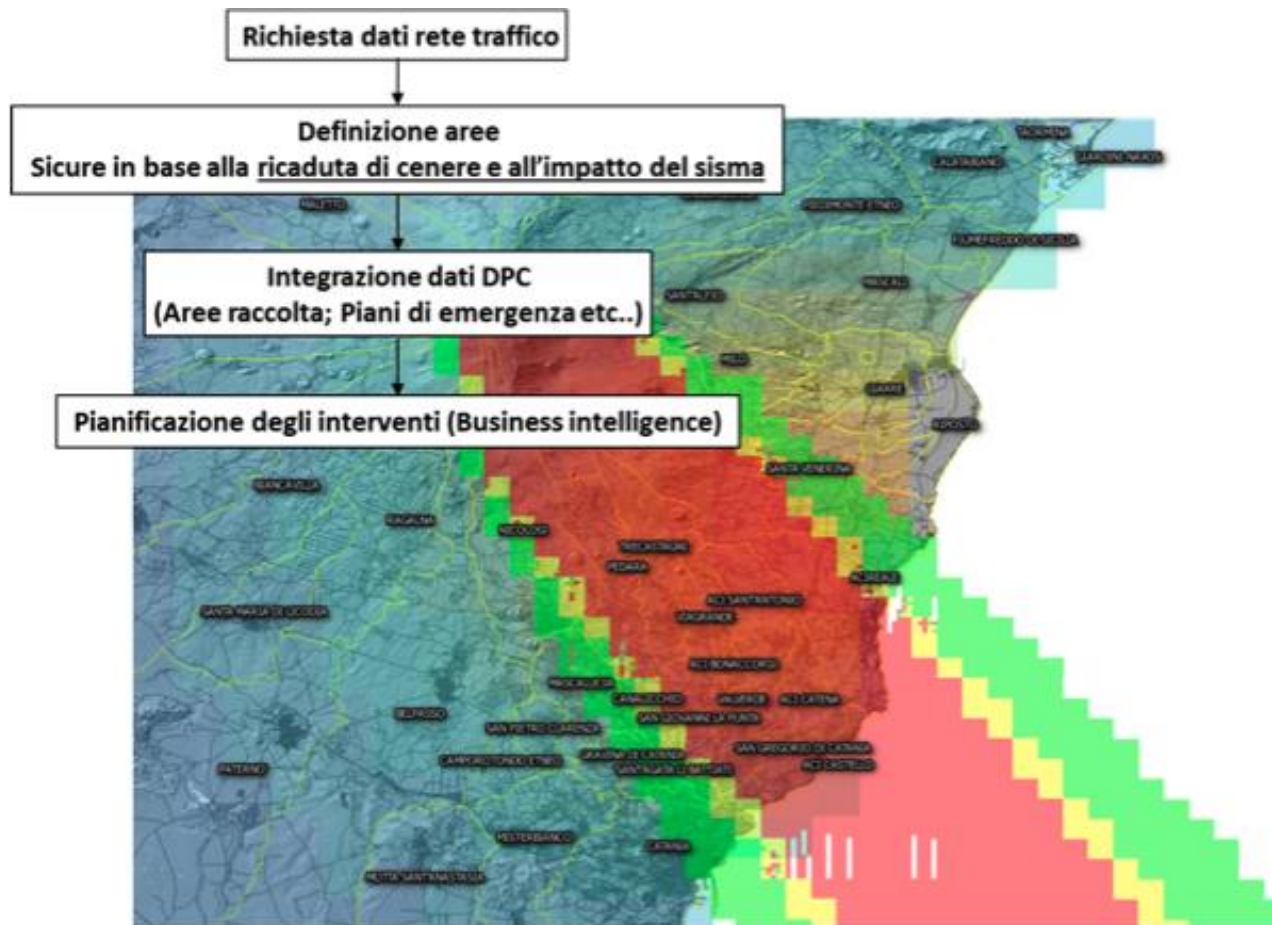

Smart Sensors



Smart Sensors

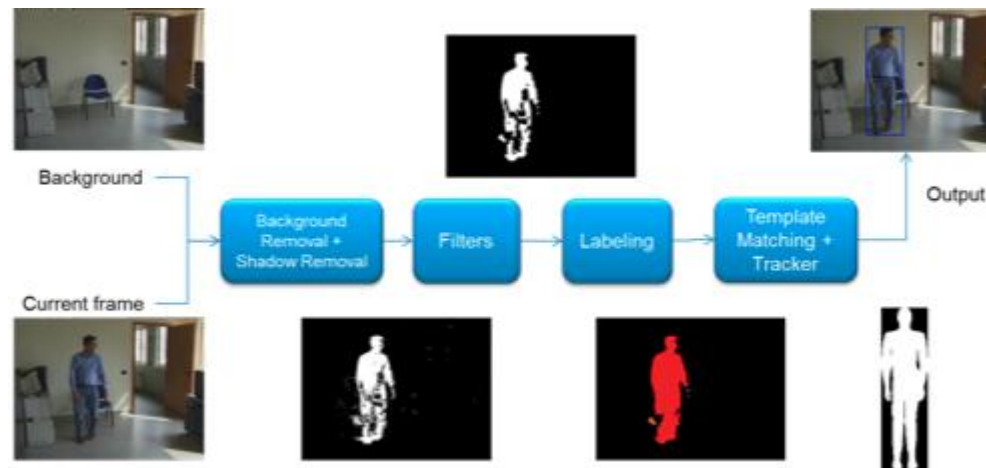

Smart Sensors



Smart Sensors

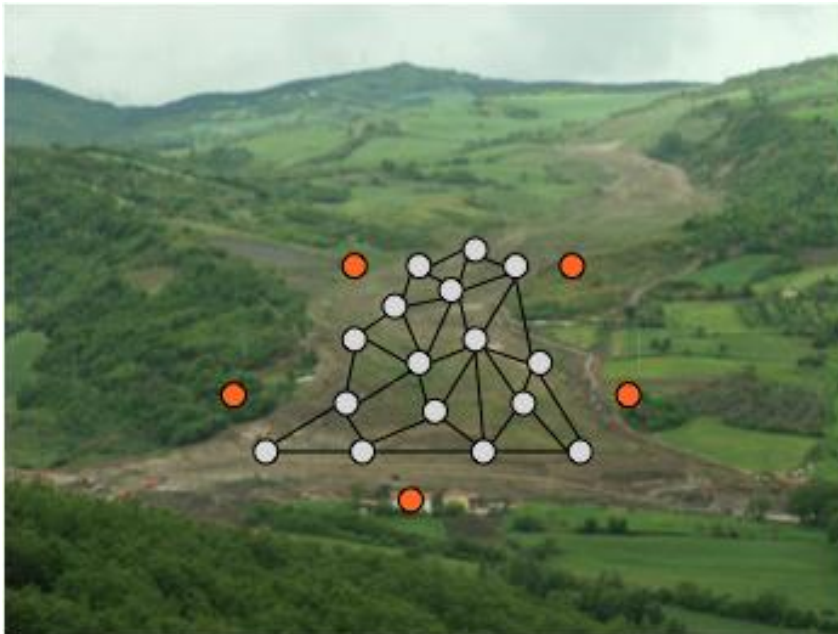

Piattaforma SIGMA

PIATTAFORMA SIGMA

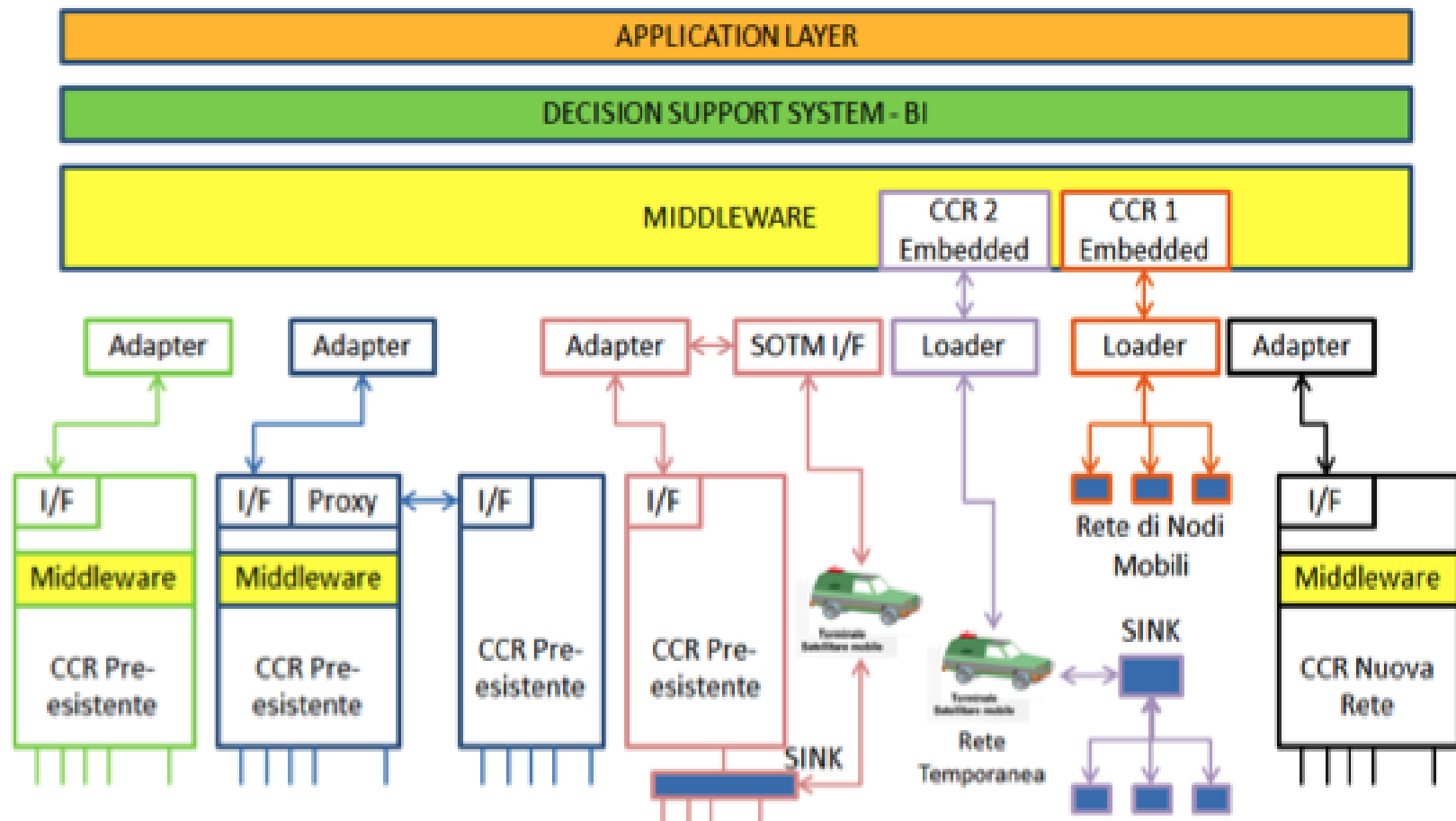

Piattaforma SIGMA

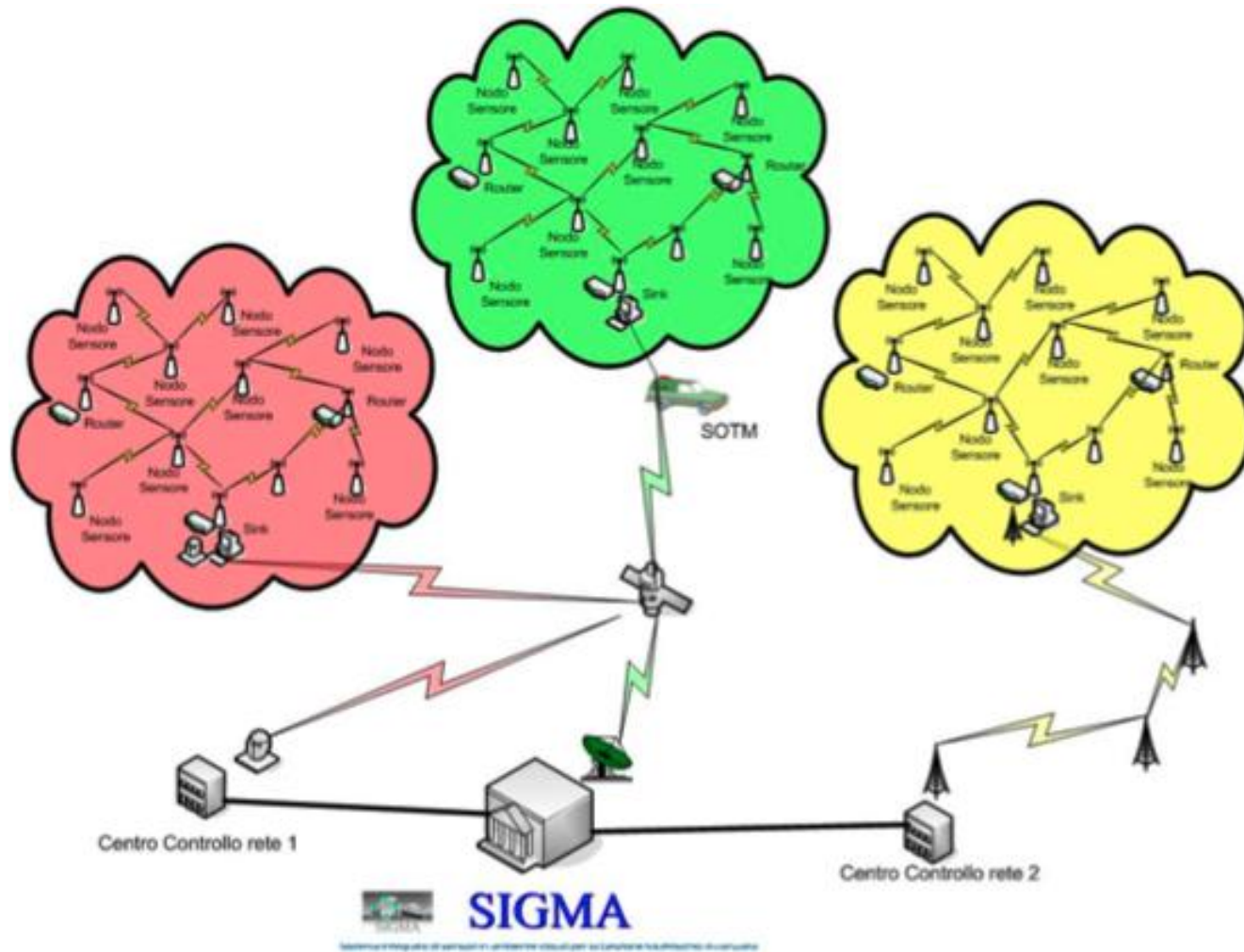

Piattaforma SIGMA

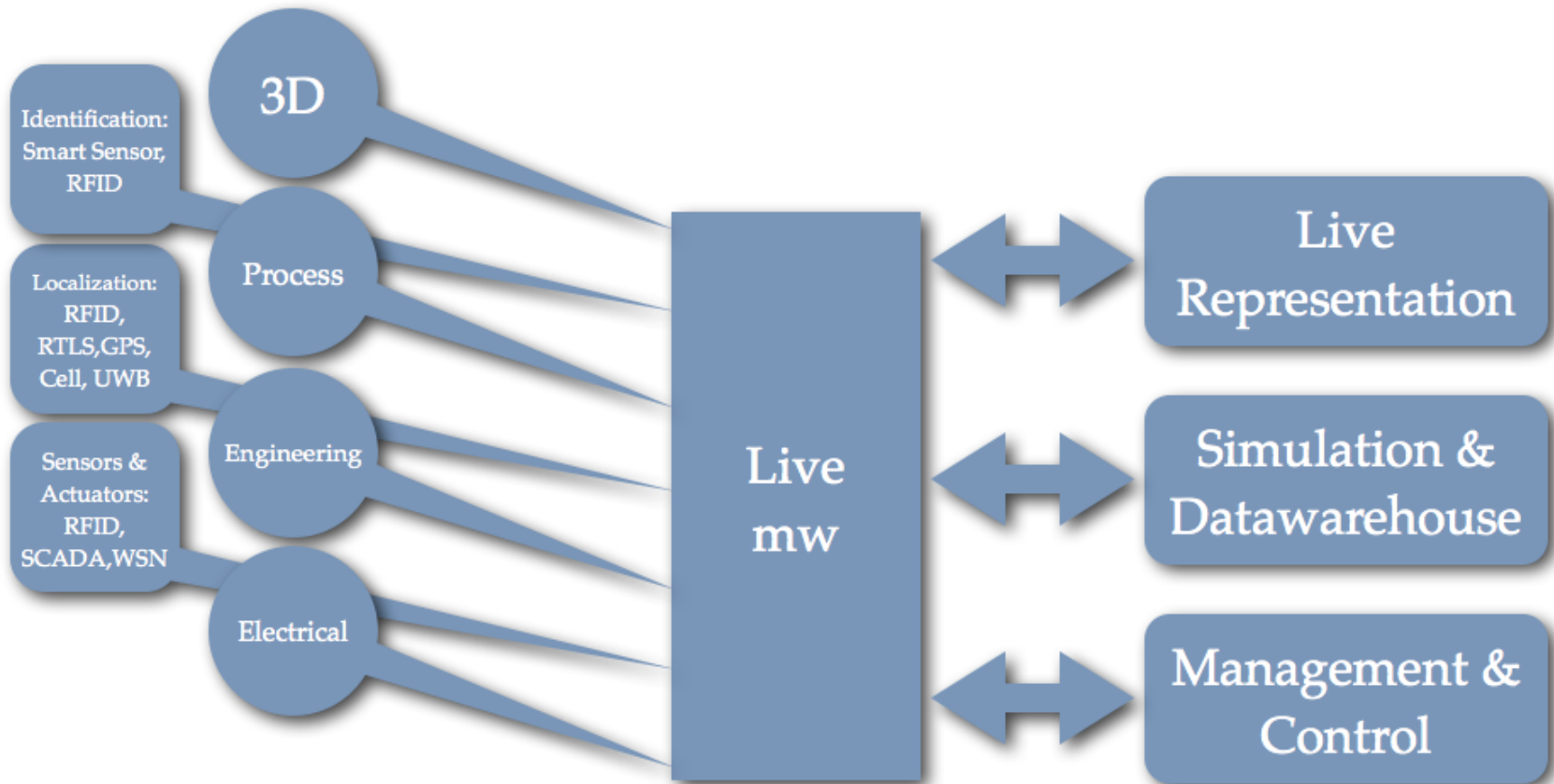

Piattaforma SIGMA

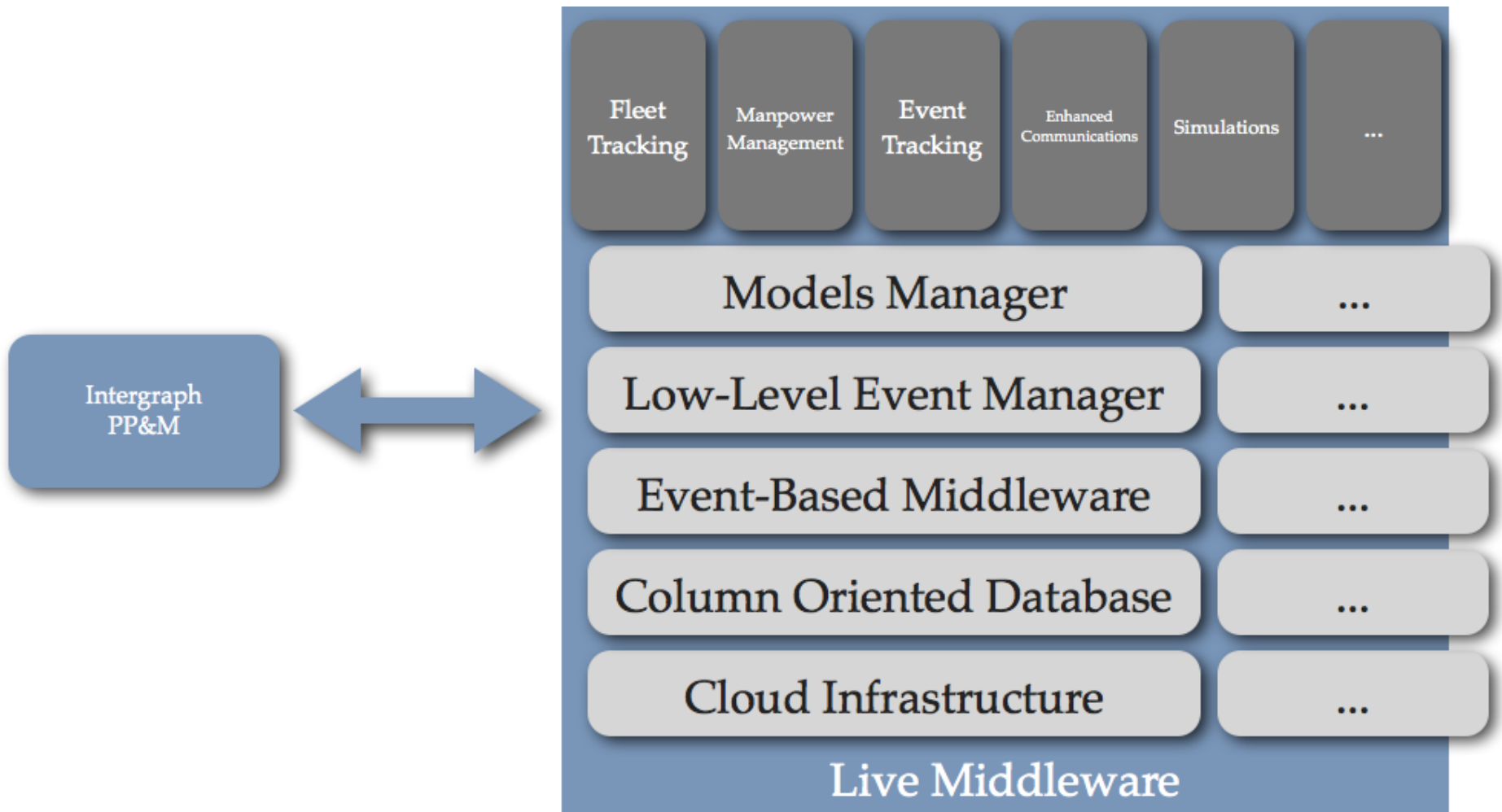

Middleware SIGMA

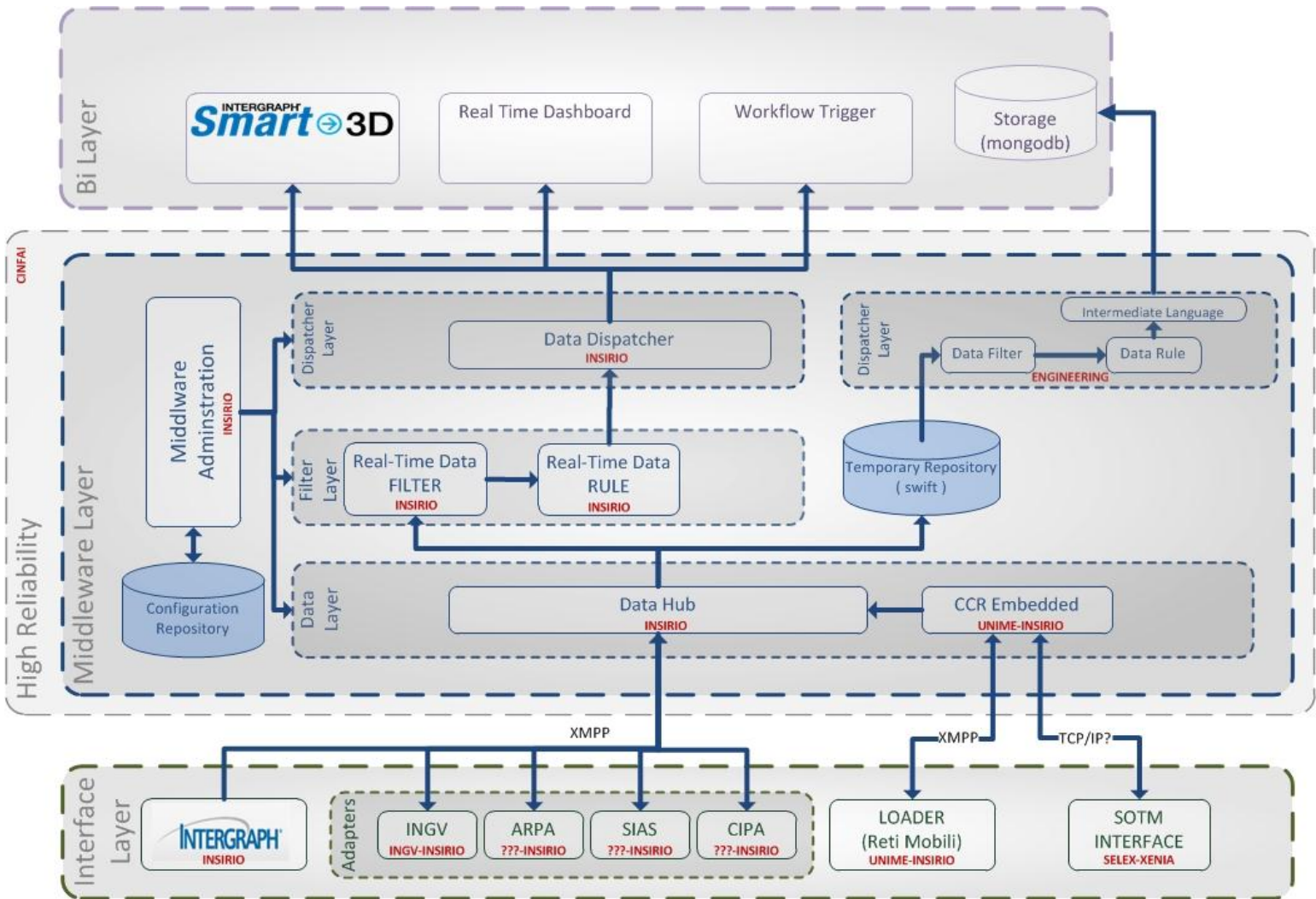

LE INTERGRAPH SMART™ SOLUTIONS E PROCESSI DOWNSTREAM E.G.: SISTEMA INTEGRATO PER LA GESTIONE MULTIRISCHIO



What's
Smart™



Multi-risks
Management

Q&A

The World
around INGR
Smart™



Progetto
SIGMA



Sestri Levante, Apr. 10th 11th 2014

**LE INTERGRAPH SMART™ SOLUTIONS E I PROCESSI DOWNSTREAM: E.G.:
SISTEMA INTEGRATO PER LA GESTIONE MULTIRISCHIO**

Presented by Maurizio M. GRANATA & Angelo ZAIA